

# IMPORTANT! READ AND FOLLOW THESE INSTRUCTIONS CAREFULLY AND KEEP FOR FUTURE REFERENCE

## ! WARNING

**WARNING** — Incorrect installation can be dangerous;

**WARNING** — Do not use the safety barrier if any components are damaged or missing;

**WARNING** — The safety barrier must not be fitted across windows;

**WARNING** — Never use without mounting cups;

This safety gate conforms to EN 1930:2011;

This safety gate is for domestic use only;

This safety gate has been designed for use with children up to 24 months of age;

Never use with a child able to climb over or dislodge/open the gate;

The surfaces that the gate is to be fixed to must be suitable for the purpose and must be structurally sound;

If the gate is used at the bottom of the stairs to prevent the child climbing up the stairs, it must be placed on the lowest stair;

If the gate is to be used at the top of the stairs to prevent the child falling down the stairs, it must not be placed on any stair below the level of the top stair;

This gate has a manual close system.

This gate is intended for indoor use and is not to be exposed to outdoor elements.

**Caution:** As part of the pressure-mounted gate engineering, there is a construction bar at the base of the gate opening. To avoid tripping or falling, always use extra caution to step over this construction bar at the base of the gate, particularly when the gate is positioned at the top of a staircase.

Can be used in conjunction with a Dreambaby® Watch-the-Step® Gate Ramp (F837) to help avoid tripping.

## NOTICE TO CUSTOMERS

**THE GAP IN THIS GATE IS NOT A FAULT.**

**THE GAP WILL DISAPPEAR WHEN THE GATE IS CORRECTLY INSTALLED.**

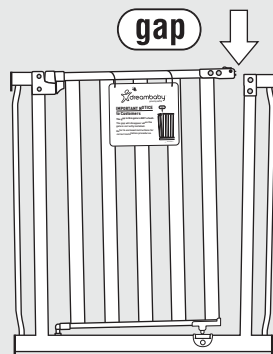

## PARTS LIST

- A - Gate Panel
- B - Upper Locking Set
- C - Gate Release Switch
- D - Smart Open-Hold System
- E - Right Upper Corner
- F - Tension Knobs
- G - Bolts with Rubber Pads
- H - Mounting Cups
- I - Double-sided Adhesive Tape
- J - Gate Frame
- K - Lower Locking Set

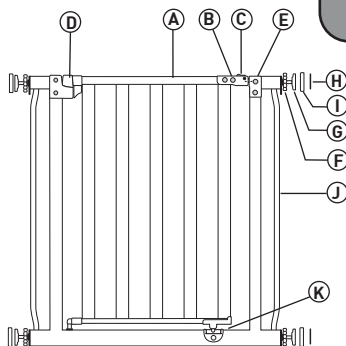

**WARNING:** This package contains small parts and sharp points in an unassembled state. Keep out of reach of children. Adult assembly required.

F x 4



G x 4



H x 4



x 4



l x 4

# INSTALLATION

1. Measure the width of the opening of where you intend to install the gate. For openings over 84cm (33in) select the appropriate Gate Extension(s), sold separately. Some examples are shown below.

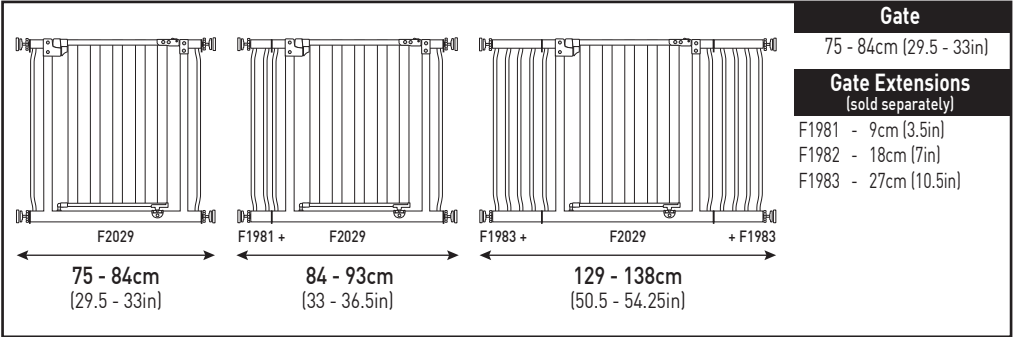

2. To connect the Gate Extensions, insert Extension Pins into the holes on the outside of the Gate Frame.

**For Gate Extension - F1981 :** insert "long end" of Extension Pins into Gate Frame.

**For Wider Gate Extensions - F1982 and F1983 :** insert "short end" of Extension Pins into Gate Frame.

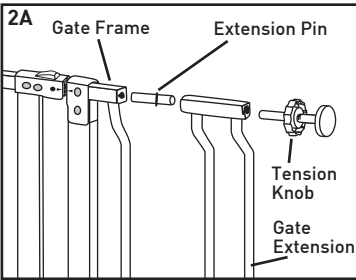

**NOTE: Carefully read point 2, regarding Extension Pins.**

For F1981 Gate Extension, insert "long end" of Extension Pins into Gate Frame.

For F1982 and F1983 Gate Extensions, insert "short end" of Extension Pins into Gate Frame.



**WARNING:**  
A maximum of 2 Gate Extensions can be used, 1 on either side of gate. Do NOT install 2 Gate Extensions on the same side of gate.

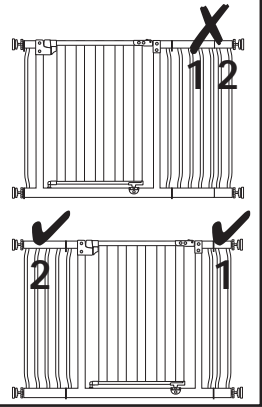

3. Place the gate in the opening so that the bottom of the Gate Frame is completely flat on the floor (3A), and it is perpendicular to the openings and the floor (3B). Then fasten the Mounting Cups to the wall (3C) with screws or double-sided adhesive tape. Note: Ensure that they are aligned vertically, so that the Mounting Cups at the top are directly above the ones at the bottom.

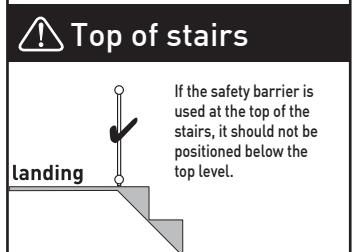
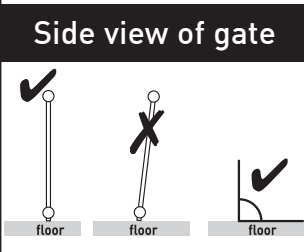
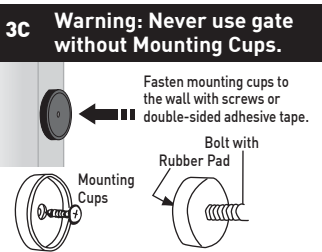
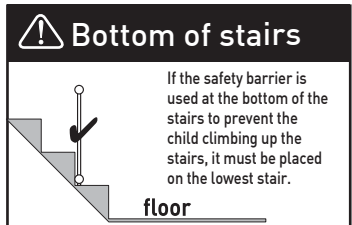
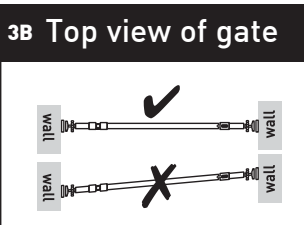
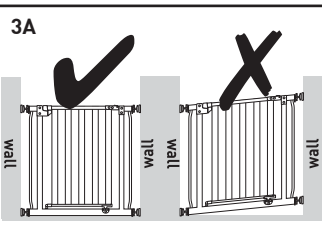

# INSTALLATION

4. Centre the gate in the opening. The distance from the Tension Knobs positioned at the bottom of the gate, to the walls, should be equal (4A).

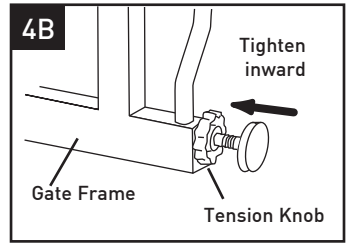
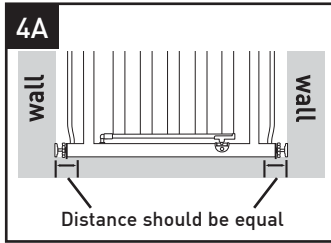

5. Tighten both of the Tension Knobs by turning them clockwise at the same time (5A and 5B). Note: make sure that the bottom of the Gate Frame remains completely flat on the floor. Ensure gate is securely fastened at both top and bottom.

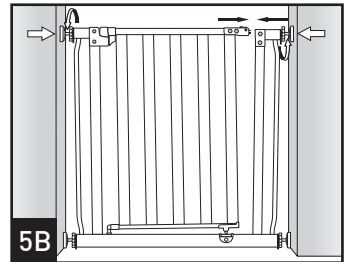
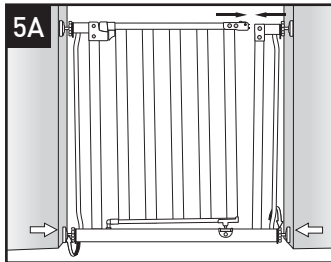

6. Tighten the Tension Knobs until the 2 Indicator Arrows, located on the Upper Locking Set and on the Right Upper Corner, align horizontally (6). Keep 1mm (0.04in) gap between Upper Locking Set and Upper Right Corner (6).

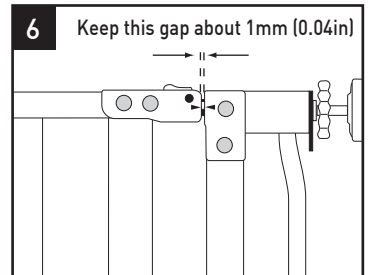

# OPERATION

7. To open the gate: Slide the Gate Release Switch (7A). Lift the Gate Panel upward (7B). Gate swings open in both directions (7C).

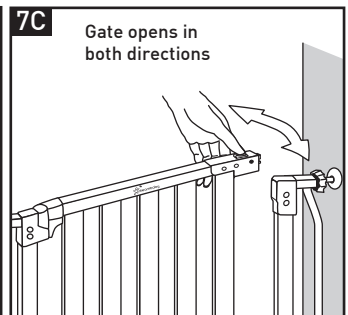
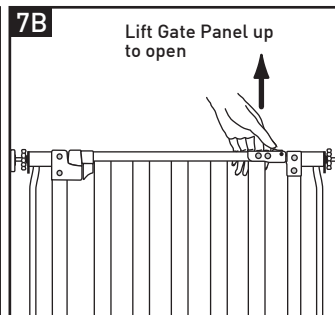
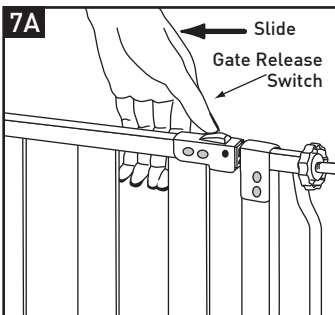

# OPERATION

8. Close the gate until it is fully locked with Upper and Lower Locking sets engaged.

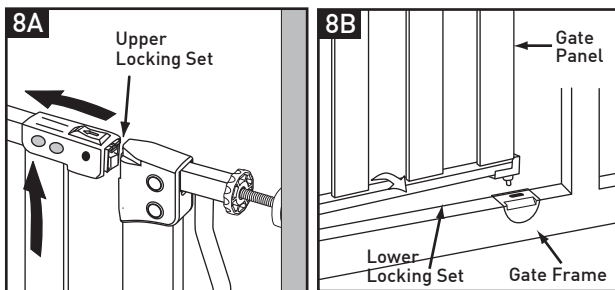

9. For easy walk through use Smart Stay Open System:  
To engage the Smart Stay Open System swing gate in chosen direction to its maximum opening. Gate will stay open (9A/9B). Close as required.  
**Caution: Keep gate closed when children are present.**

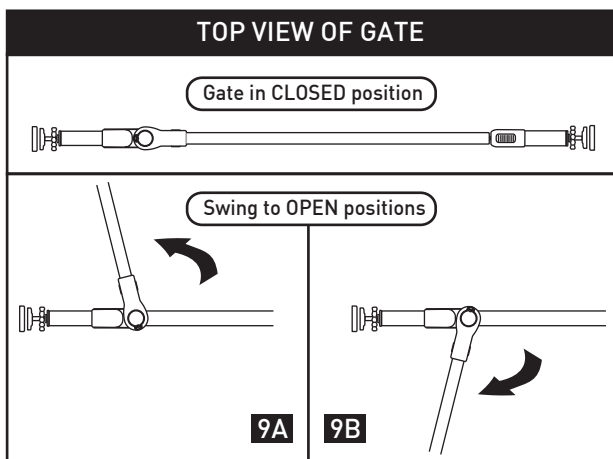
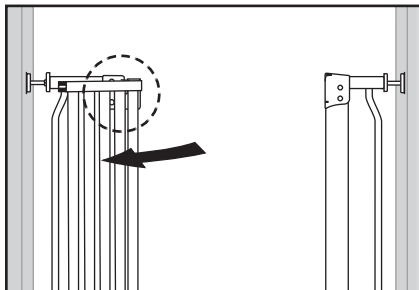

# MAINTENANCE & CARE

- Gate must be fitted according to instructions, to ensure it works correctly.
- Regularly check Tension Knobs, Rubber Pads and Mounting Cups to make sure the gate is securely in place and closes correctly. Adjust as required.
- Only use Dreambaby® spare parts. Any additional and replacement parts should be obtained from Tee-Zed Products.
- To clean, wash surface with a damp cloth using mild detergent and warm water.  
Never clean with abrasive, ammonia, bleach or spirit based type cleaners.

# CONTACT DETAILS

Tee-Zed acknowledges that its customers may be entitled to statutory consumer guarantees and does not seek to exclude or limit them. These guarantees include that Tee-Zed's products are of acceptable quality. This Tee-Zed product is for the specific purpose detailed in the instructions and packaging and Tee-Zed considers use outside of that purpose to be abnormal use. To the maximum extent permitted by law, Tee-Zed does not accept any liability for damage:

- arising from abnormal use of the products;
- caused by installation or removal of the products other than in accordance with the supplied installation and removal instructions; or
- arising under the law of tort or contract.

Dreambaby® products by 

Tee-Zed Products Pty Ltd  
PO Box 2022, Bondi Junction NSW 1355  
**Australia** Tel: +61 (0)2 9386 4000  
info@tee-zed.com.au

Tee-Zed Products (N.Z.) Ltd  
PO Box 64013, Botany Town Centre Auckland  
**New Zealand** Tel: +64 (0)9 274 8788  
info@tee-zed.co.nz

Tee-Zed Products Ltd  
PO Box 29227, Dunfermline, KY12 2DN  
**United Kingdom** Tel: +44 (0)844 800 9445  
info@tee-zed.co.uk

[www.dreambaby.com.au](http://www.dreambaby.com.au)  
[www.dream-baby.co.nz](http://www.dream-baby.co.nz)  
[www.dreambaby.co.uk](http://www.dreambaby.co.uk)  
[facebook.com/Dreambabysafety](https://facebook.com/Dreambabysafety)  
[youtube.com/user/Dreambabytv](https://youtube.com/user/Dreambabytv)



Made in Hangzhou, Zhejiang, China.



©2015 Tee-Zed Products Pty Ltd

Broadcast Yourself™